



SDP

叠螺式污泥脱水机

SDP sludge dewatering screw press



SDP 叠螺式污泥脱水机

SDP sludge dewatering screw press

简介 Description

SDP系列采用了一种全新的污泥处理解决方案,运用前沿技术,流线型和自动编程设计,使操作更加方便、准确,同时提供了一种简单的工艺、低投资系统、高效率 and 节能。

SDP Series introduced a new solution for sludge treatment with a new cutting-edge technology, streamline and automatic programmed design to make the operation much more convenient and accurate while provide a simple process, low system investment, high efficiency as well as energy-saving.

SDP叠螺式污泥脱水机的核心结构是由不锈钢制成的固定环和游动环组成,游动环的内径相对小于螺旋轴的外径,由拉杆固定到位。

The core structure of SDP screw press is consisted of multiple layers of Fixed and Moving ring made by stainless steel sUS304 which secured in place by a tie rod while the inner diameters of the moving rings are relatively smaller than the outer diameter of screw and Fixed rings.

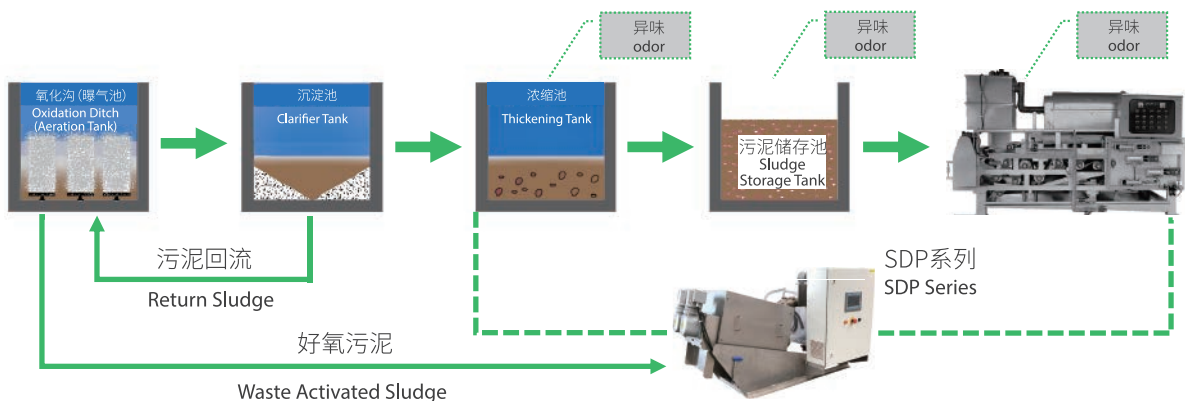
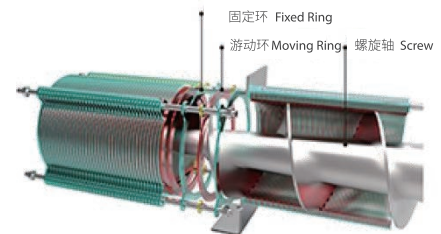

传统的污泥处理在污泥脱水前需要大量的预处理过程,采用SDP脱水工艺可以直接处理来自氧化沟(曝气池)的低浓度污泥,具有去除污泥异味、降低浓缩池及其他相关设备投资成本、不会发生传统污泥浓缩池或储存池中在缺氧或厌氧条件下的污泥磷释放,进一步简化了工艺流程,稳定脱水过程。

The traditional sludge treatment required a lots of pre-treatment process before the dewatering of sludge begin With SDP, the dewatering process can now be processed a low concentrated sludge from Oxidation ditch (aeration tank which provide the advantages in removing odor from sludge, reduce investment cost for Thickener tank and other related equipment as well as help in stabilizing the amount of phosphorus return into oxidation ditch which further implement a stable dewatering process.



工作原理

脱水过程从浓缩区的初始部分开始,此时螺旋轴通过固定环与游动环之间旋转并使污泥中的游离水从污泥中分离。浓缩后的滤液将在底部排水孔排出,而污泥将继续进入脱水区,在脱水区内螺旋轴的螺距和环之间的间隙减小,通过调整背压板的间隙,提高内部脱水腔体的压力,进行挤压脱水,排出干泥饼。

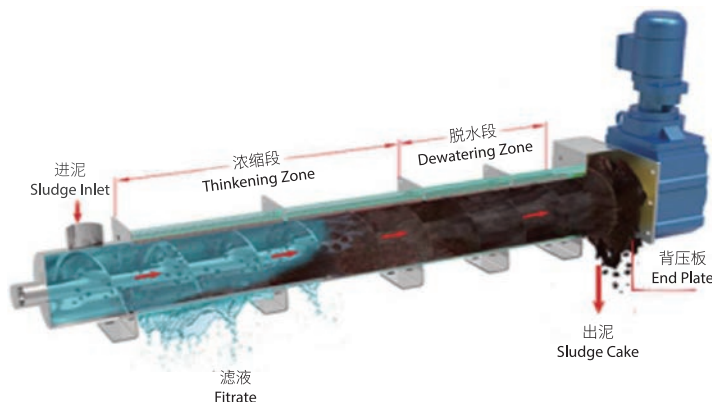

固定环和游动环的结构具有无堵塞功能,其中游动环通过螺旋轴移动,并不断清除间隙中的污泥,以防止堵塞。

Working Principle

The dewatering process begin at the initial section called Thickening zone, when the screw shaft rotating and separating liquid from solid sludge by the gaps between the multi-disc rings. the filtrated will then be discharge at the bottom drain hole while sludge will moving on to Dewatering zone where the pitch of the screw and the gaps between the multi-rings decrease at the end of drum thus increasing internal pressure at the end plate to discharge dry sludge cake.

The structure of Fixed and moving rings provided a clog-free feature in which the moving rings are mobilizing by the screw and continuously cleans the sludge out of the gaps to prevent clogging.

优势

- 能广泛应用于许多行业的污泥处理,包括城市污水、食品屠宰养殖、印刷、染色、石油化工、造纸、皮革、制药等。
- 具有含油污泥的处理能力
- 具有处理2000mg/L至50000mg/L低浓度到高浓度污泥的能力。
- 游动环和自动喷淋清洗系统在处理过程中提供自动清洗能力,防止堵塞,不需要人员操作设备,可连续运行24小时。
- 控制面板配有变频器和PLC,并具有自动和手动功能。
- 无磨损结构,使用寿命长,安装占用空间小。

Advantages

- Widely used in many industries sludge treatment including municipal sewage, food, slaughtering breeding printing dyeing oil chemical, paper industry, leather, pharmaceutical, etc.
- Oily sludge handling capability.
- Ability to handling low concentration sludge from 2,000 mg/L up to 50,000mg/L.
- Rotating ring and automatic spray cleaning system provide self-cleaning ability during process and prevent clogging allowing a continue operation for 24 hour without user assist.
- Control panel equipped with inverters and plc for automatic and manual function.
- Wear free structure, long service life and utilizing a small footprint for installation.

型号说明 Type description

SDP - 1 0 1



螺旋轴数量

Number of screw shaft

螺旋轴直径×10(mm)

Cylinder diameter x 10(mm)

叠螺式污泥脱水机

Sludge Dewatering Screw Press



特点 Features

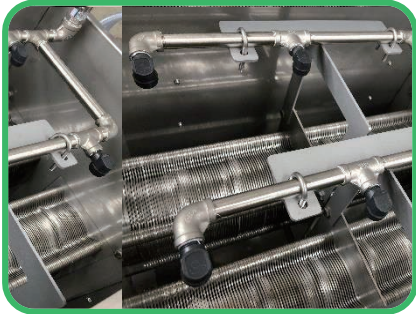

电磁阀自动控制清洗水, 使设备运行保持高效率。

Automatic self-cleaning system control by solenoid valve for disc cleaning and maintain operation efficiency.

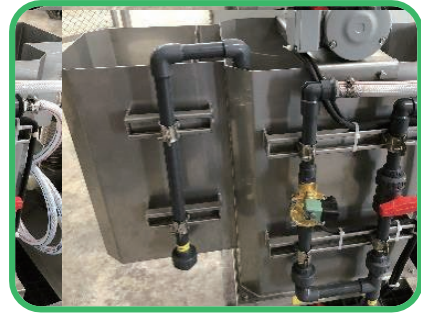

管路分配用于絮凝剂与清洗水的加入, 可自动或手动操作。

Pipe line allocated for polymer dosing and cleaning system both automatic and manual operation.

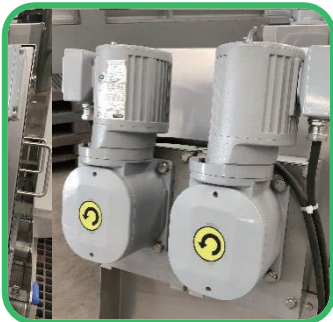

螺旋轴主体有各种尺寸和数量, 最多4个螺旋轴主体。

Screw end plates are available with various size and number, up to 4 screws shaft.



主体由多重固定环和游动环构成螺旋轴贯穿其中形成过滤装置。螺旋轴将连续旋转并分离污泥中的水分。

Multi-disc composed of fixed and moving rings are secured in place by a tie rod between the screw shaft which will continuously rotating and filtering liquid from sludge.

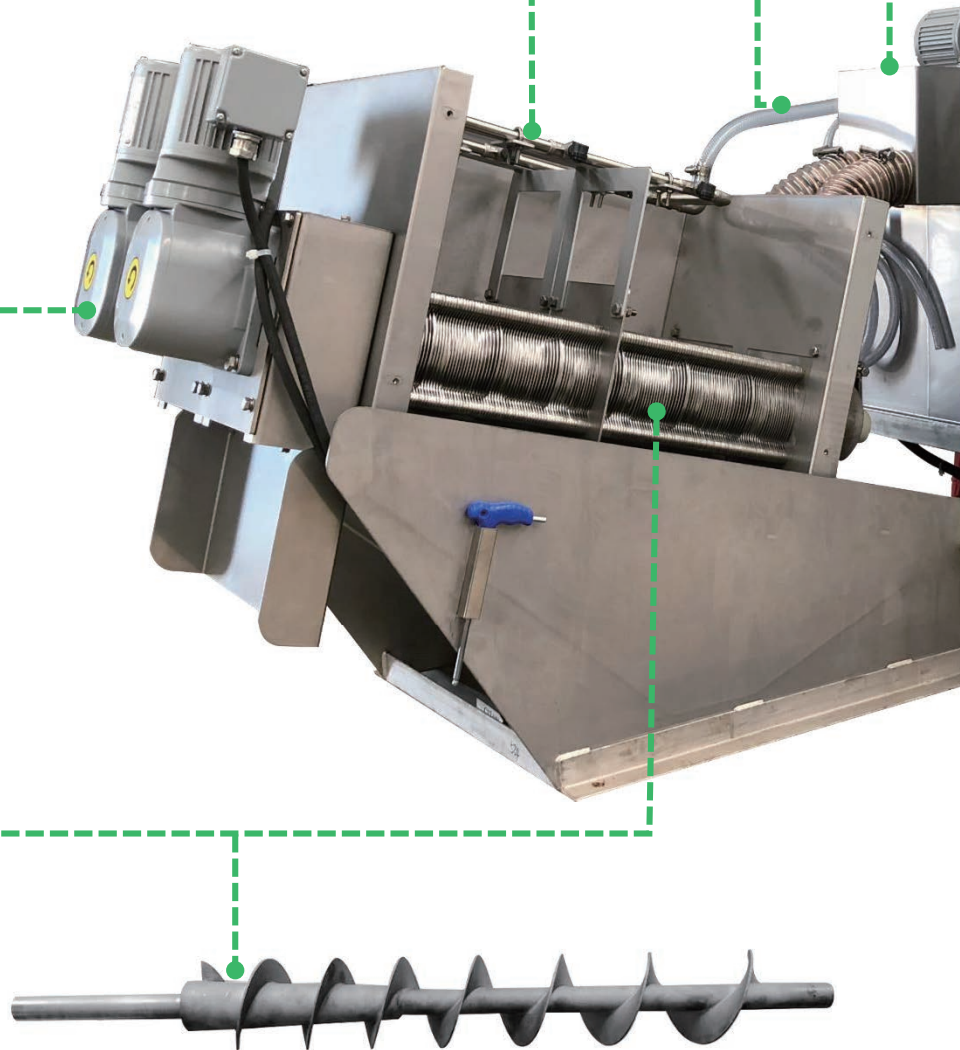

螺旋轴表面有碳化钨涂层或进行合金堆焊。

Tungsten carbide coating screw shaft



污泥计量槽与絮凝槽由激光切割的SUS304不锈钢板焊接而成。

Laser cutting stainless steel SUS304 for sludge water tank and polymer mixing tank



不锈钢SUS304混合搅拌桨, 使污泥与絮凝剂充分混合反应, 产生矾花。

Stainless steel SUS304 Mixing agitator for polymer mixing and prevent coagulation of sludge.



具有友好的触摸控制面板, 方便自动和手动操作。

Touch screen control panel with user friendly interface for convenient operation in both automatic and manual function.



螺旋轴与搅拌桨旋转速度可由变频器调节控制。

Inverter controller for screw shafts and Mixing agitator speed adjusting.

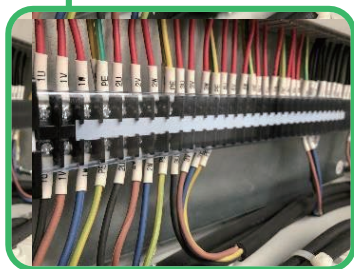

可作为周边设备的控制终端, 包括污泥泵、加药泵、输送机。

Available terminals for collaborate with external equipment including sludge pump, dosing pump and conveyor.



可编程逻辑控制器(PLC), 可根据用户的需求提供灵活的操作和控制。

Programmable Logic Controller (PLC) provides flexible operation and overall control line of machine according to the user needs.



成本效益

SDP创新的工作原理,由于其低速运行(2-3转/分)使其能够在废水处理系统中能耗大幅度节省,并且使用清洗水量低,产生噪音小。

SDP本身具备污泥浓缩功能,可直接处理曝气池内的好氧污泥,不需建立污泥浓缩池,提高了污水处理系统中的除磷效果,降低了整体投资成本。



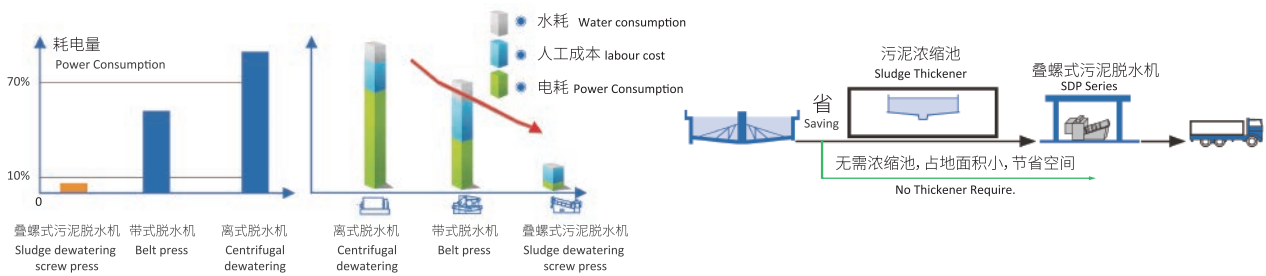

Cost efficiency

With innovation and working principle of sDP allowing it to leverage a cost efficiency in energy consumption for wastewater treatment system, due to its low speed running(2-4 rpm) while operating, provide sDP to consume energy at low rate (average energy consumption at 0.1-0.01 kwh/kg-DSO, low water consumption for cleaning as well as generate minimum noise.

By using multi-disc technology the sludge can be draw directly from aeration tank and secondary sedimentation tank without establishing a sludge thickeners process, thus, enhancing phosphorus removal effect in wastewater treatment system as well as decreasing a total investment cost as a whole.



各类脱水设备对比 Comparison Chart

脱水机种类 Machine Type	 叠螺式污泥脱水机 Sludge dewatering screw press	 板框压滤机 Frame filter press	 带式压滤机 Belt press	 离心式脱水机 Centrifugal dewatering
低浓度污泥脱水 Low concentrated sludge dewatering	√	⊗	⊗	⊗
需要配备浓缩池 Thickener requirement	⊗	√	√	√
24小时自动运行 24 Hr automatic operation	√	⊗	⊗	⊗
安装区域 Installation area	•	•••	•••	••
劳动强度 Labor intensity	•	•••	•••	•
噪音 Noise	•	•••	••	••••
能耗 Energy consumption	•	•••	••	••••
运营成本 Operating cost	•	••	•••	•••
保养 Maintenance	•	•••	•••	••••

* 标志: • (低) •• (中等) ••• (高) •••• (非常高)
Symbol: • (Low) •• (Moderate) ••• (High) •••• (Very high)

性能参数 Specification

泵型号 Model	绝干量Kg.DS/h Dried sludge		污泥处理量 Treating capacity (m ³ /h)					
	低浓度 Low concentration	高浓度 High concentration	2000mg/l	5000mg/l	10000mg/l	20000mg/l	25000mg/l	50000mg/l
SDP-131	5	10	2.5	1	1	0.5	0.4	0.2
SDP-132	10	20	5	2	2	1	0.8	0.4
SDP-251	15	30	7.5	3	3	1.5	1.2	0.6
SDP-252	30	60	15	6	6	3	2.4	1.2
SDP-301	30	60	15	6	6	3	2.4	1.2
SDP-302	60	120	30	12	12	6	4.8	2.4
SDP-303	90	180	45	18	18	9	7.2	3.6
SDP-304	120	240	60	24	24	12	9.6	4.8
SDP-351	50	100	25	10	10	5	4	2
SDP-352	100	200	50	25	20	10	8	4
SDP-353	150	300	75	30	30	15	12	6
SDP-354	200	400	100	40	40	20	16	8
SDP-401	80	160	40	16	16	8	6.4	3.2
SDP-402	160	320	80	32	32	16	12.8	6.4
SDP-403	240	480	120	96	48	24	19.2	9.6
SDP-404	320	640	160	64	64	32	25.6	12.8

运行条件 Operating Condition

泵型号 Model	电机功率 Shaft Power(kW)			清洗水压 Rinsing Water Pressure (MPa)	清洗水量 Rinsing Water (l/h)
	螺旋轴 Screw	搅拌桨 Mixer	合计 Total		
SDP-131	0.18x1	0.18x1	0.36		43
SDP-132	0.18x2	0.18x1	0.54		86
SDP-251	0.55x1	0.37x1	0.92		58
SDP-252	0.55x2	0.37x1	1.47		116
SDP-301	0.75x1	0.55x1	1.3		93
SDP-302	0.75x2	0.55x1	2.05		186
SDP-303	0.75x3	0.75x1	3		279
SDP-304	0.75x4	0.75x1	3.75	0.1-0.2 (无需配高压冲洗装置)	372
SDP-351	1.1x1	0.75x1	1.84		126
SDP-352	1.1x2	0.75x1	2.95		252
SDP-353	1.1x3	1.1x1	4.4		378
SDP-354	1.1x4	1.5x1	5.9		504
SDP-401	1.5x1	1.5x1	3		115
SDP-402	1.5x2	1.5x1	4.5		230
SDP-403	1.5x3	1.5x2	7.5		345
SDP-404	1.5x4	1.5x2	9		460



尺寸 Dimension

泵型号 Model	滚筒规格 Cylinder Specification (mm)	泥饼出口距离 Sludge Cake Outlet Distance (mm)	机型尺寸 Dimension(mm)			净重 Net Weight (kg)	运行重量 Operating Weight (kg)
			长 Length	宽 Width	高 Height		
SDP-131	Ø130 x 1	265	1870	730	1170	230	395
SDP-132	Ø130 x 2	265	2000	960	1230	338	595
SDP-251	Ø250 x 1	389	2690	880	1600	480	805
SDP-252	Ø250 x 2	389	2810	1120	1600	760	1320
SDP-301	Ø300 x 1	506	3300	1000	1700	750	1275
SDP-302	Ø300 x 2	506	3500	1300	1700	1260	2225
SDP-303	Ø300 x 3	506	3700	1650	1700	1700	3030
SDP-304	Ø300 x 4	505	4000	2050	1750	2100	4150
SDP-351	Ø350 x 1	474	3610	1100	1850	1050	1915
SDP-352	Ø350 x 2	479	3820	1490	1850	1900	3205
SDP-353	Ø350 x 3	479	4120	1770	1850	2700	4830
SDP-354	Ø350 x 4	479	4320	2290	1850	3600	6515
SDP-401	Ø400 x 1	801	4550	1180	2250	1998	3425
SDP-402	Ø400 x 2	801	4870	1710	2250	3538	6645
SDP-403	Ø400 x 3	803	4790	2550	2250	5300	9710
SDP-404	Ø400 x 4	801	4840	3140	2250	6900	12960



水处理系统专业合作伙伴

免费咨询电话

400-657-9066

本型录内容如有变更，恕不另行通知。
We reserve the right to change content without notice.

川源(中国)机械有限公司版权所有 all rights reserved. CY-17

